

THE INFORMATION CONTAINED IN THIS DRAWING IS THE SOLE PROPERTY OF DEL SMITH MANUFACTURING. ANY REPRODUCTION IN PART OR WHOLE WITHOUT THE WRITTEN PERMISSION OF DEL SMITH MANUFACTURING IS PROHIBITED.

Request For a Quote

Note: In order for us to respond as quickly as possible please, fill out the applicable information and fax it back to us. Our fax number is 323-265-3233.

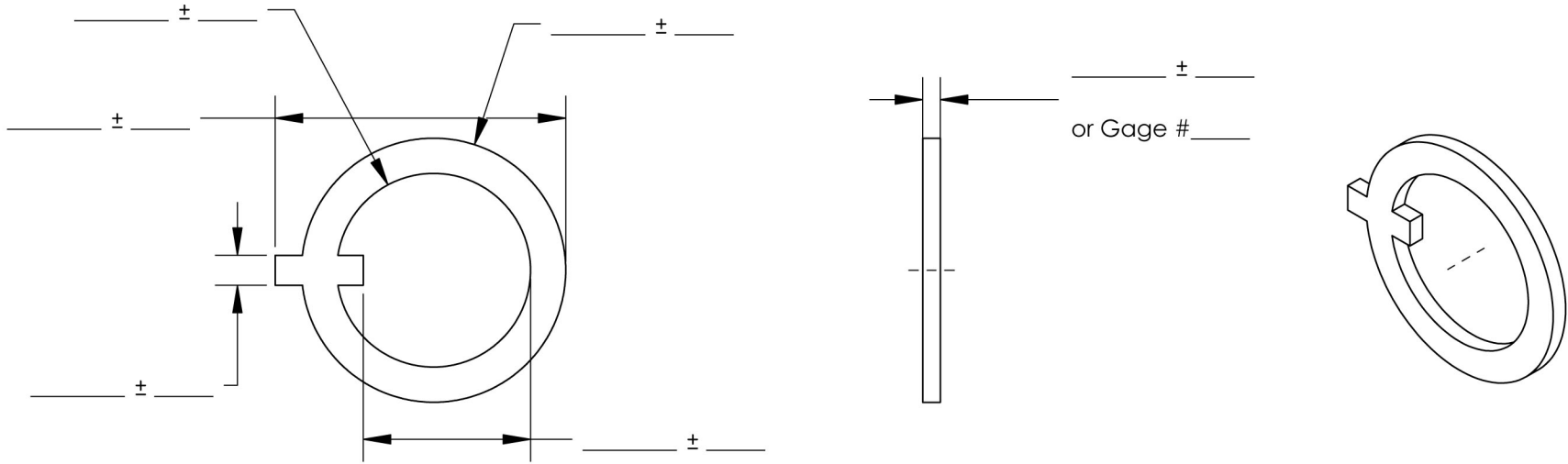

Style 1031

Specifications

Quantity _____

Material _____

cert req'd YES NO (circle one)

Heat Treat _____

cert req'd YES NO (circle one)

Plating _____

cert req'd YES NO (circle one)

Other _____

Your Information

Company _____

Contact _____

Telephone (____) ____ - ____ x ____

Fax (____) ____ - ____

Previous Job History

(if this is repeat order)

Last Ordered on __/__/__

Your last PO # _____

Our Invoice # _____

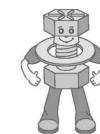

Mr. Washerman

Mr Washerman

1432 Chico ave. S. El Monte CA 91733
tel. 323-265-1205 fax 323-265-3233
www.mrwasherman.com

1031 Washer